

NOTES: UNLESS OTHERWISE SPECIFIED.
 1. STANDOFF SPACING MAY VARY WITH LENGTH.

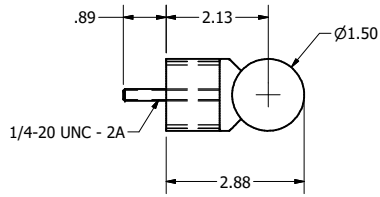

ROUND METAL

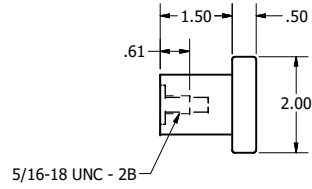

FLAT METAL

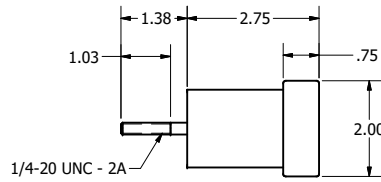

FLAT WOOD

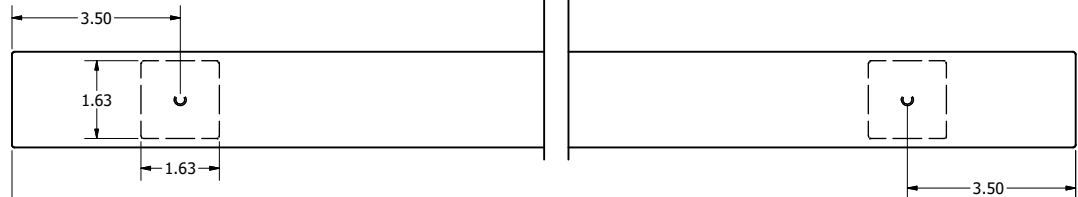
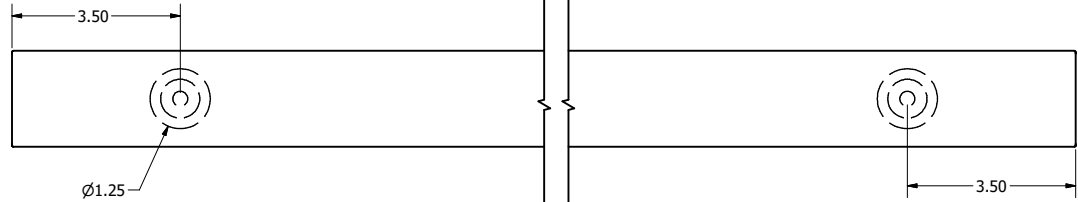
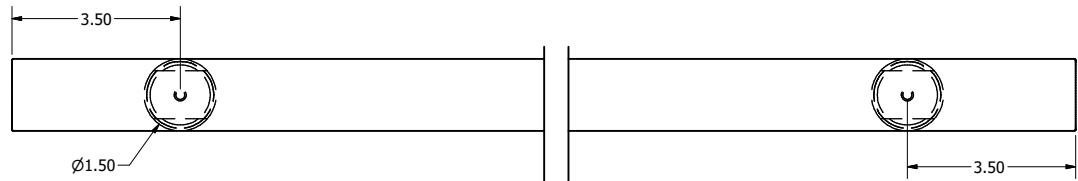

36.00 STANDARD LENGTH
 AVAILABLE IN 1" INCREMENTS

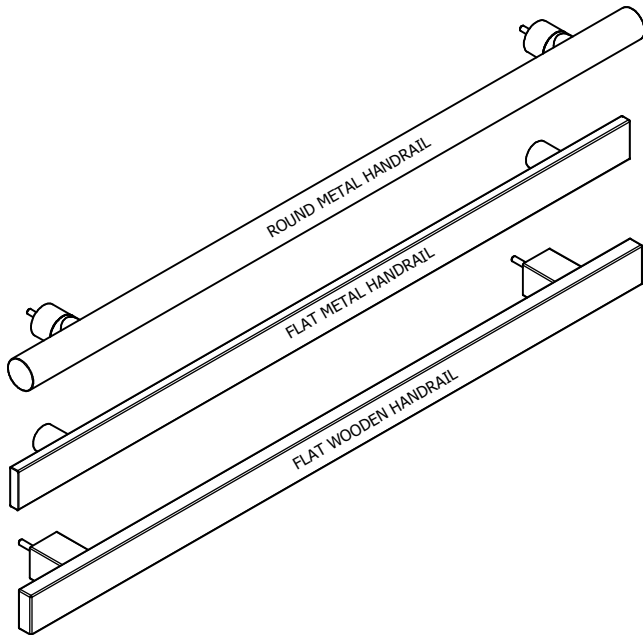

TOLERANCES ANGULAR: ± 1' .XXX: ± .005 .XX: ± .015	DRAWN	1/4/2017	 ROCKY MOUNTAIN ELEVATOR PRODUCTS <small>SOLE AS THE TRADES</small>		
	WLL				TITLE
	CHECKED		HANDRAIL DETAIL		
	QA		SIZE	DWG NO	REV
	MFG		C	CAB-600000	
APPROVED		SCALE	SHEET 1 OF 1		
DO NOT SCALE DRAWING					